



HOSHIZAKI

CERTIFICATION



HACCP International



ISO9001

FM-120KS-HC FLAKE ICE MAKER



Key Features



NATURAL
REFRIGERANTS

**Eco-Friendly
Refrigerant**



Easy for maintenance
Notify when parts should
be replaced

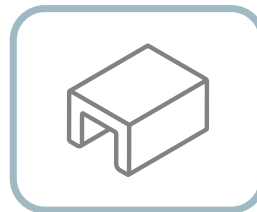

**Stainless Steel
Exterior**

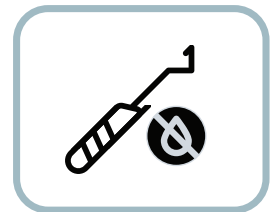

**Stainless Steel &
Greaseless Auger**

Our Flake & Nugget Ice Makers belong to the true allrounders of the Hoshizaki product line-up. These powerful, durable and sustainable machines are highly popular across different market segments, such as in food preparation / processing, as well as in hotels, bars, restaurants and catering businesses.



Dimensions & Specifications

TOP

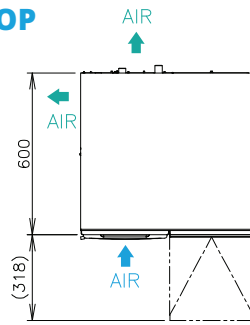

ICE SHAPE

FLAKE



LEFT SIDE

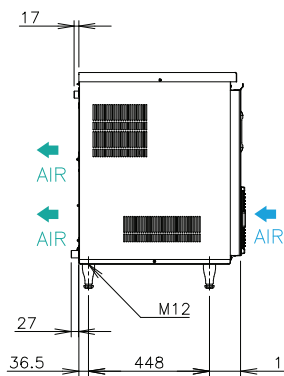

FRONT

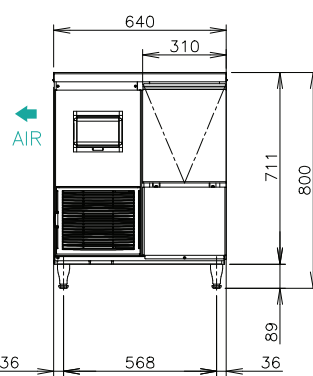

RIGHT SIDE

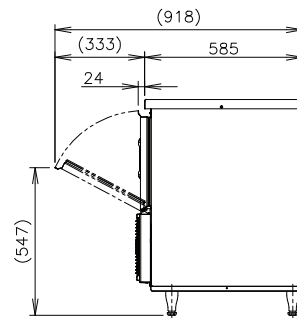

BACK

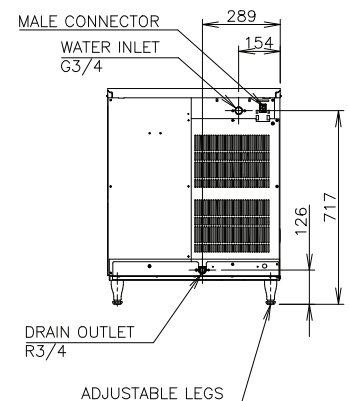

MODEL		FM-120KS-HC
ICE SHAPE		Flake Ice
POWER SUPPLY		1 Phase 220-240V 50Hz Capacity: 0.53kVA (2.2A)
AMPERAGE		2.2A Started: 8.8A
ELECTRIC CONSUMPTION		353W
HEAT REJECTION	(AT32°C / WT21°C)	820W
ICE PRODUCTION PER 24H	(AT10°C / WT10°C)	137kg
	(AT21°C / WT15°C)	119kg
	(AT32°C / WT21°C)	88kg
STORAGE CAPACITY		Approx. 26kg
WATER CONSUMPTION PER 24H	(AT32°C / WT21°C)	95L
REFRIGERANT		R290 / 85g
OUTSIDE DIMENSIONS		640mm(W) x 600mm(D) x 800(- 833)mm(H)
PACKAGE		Carton 746mm(W) x 706mm(D) x 887mm(H)
WEIGHT		62kg (Gross 76kg)
OPERATING CONDITIONS		Ambient Temp:5-40°C, Water Supply Temp:5-35°C, Water Supply Pressure: 0.05-0.78MPa, Voltage Range: Rated Voltage±6%



HOSHIZAKI

HOSHIZAKI MALAYSIA SDN. BHD.

No. 12, Jalan Penyajak U1/45B. Hicom-Glenmarie
Industrial Park, 40150 Shah Alam, Selangor
TEL (+60) 3 5569 8023 <https://hoshizaki.com.my/>

